

DOUBLE & KING SIZE

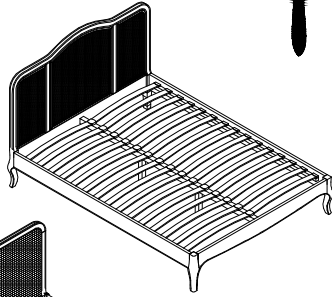

SUPER KING SIZE

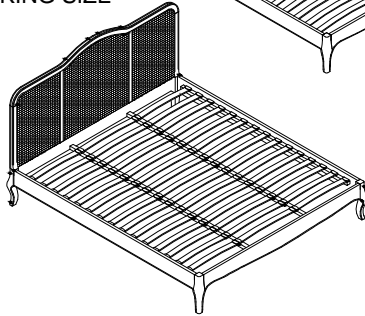

PLEASE READ this sheet prior to assembly to familiarise yourself with the various stages of construction.

Carefully open the pack supplied and check the contents against the parts and fittings check list. Do not destroy any of the packaging until you are certain that you have all the necessary parts for the assembly.

Please ensure that the packaging is disposed of in a safe and environmentally friendly way.

CAUTION: There are small components used in the construction of this unit. These loose items should be kept away from young children during assembly, to avoid the danger of choking.

IMPORTANT: BEFORE STARTING TO ASSEMBLE THE BED - PLEASE READ THESE INSTRUCTIONS CAREFULLY.

Parts Identification

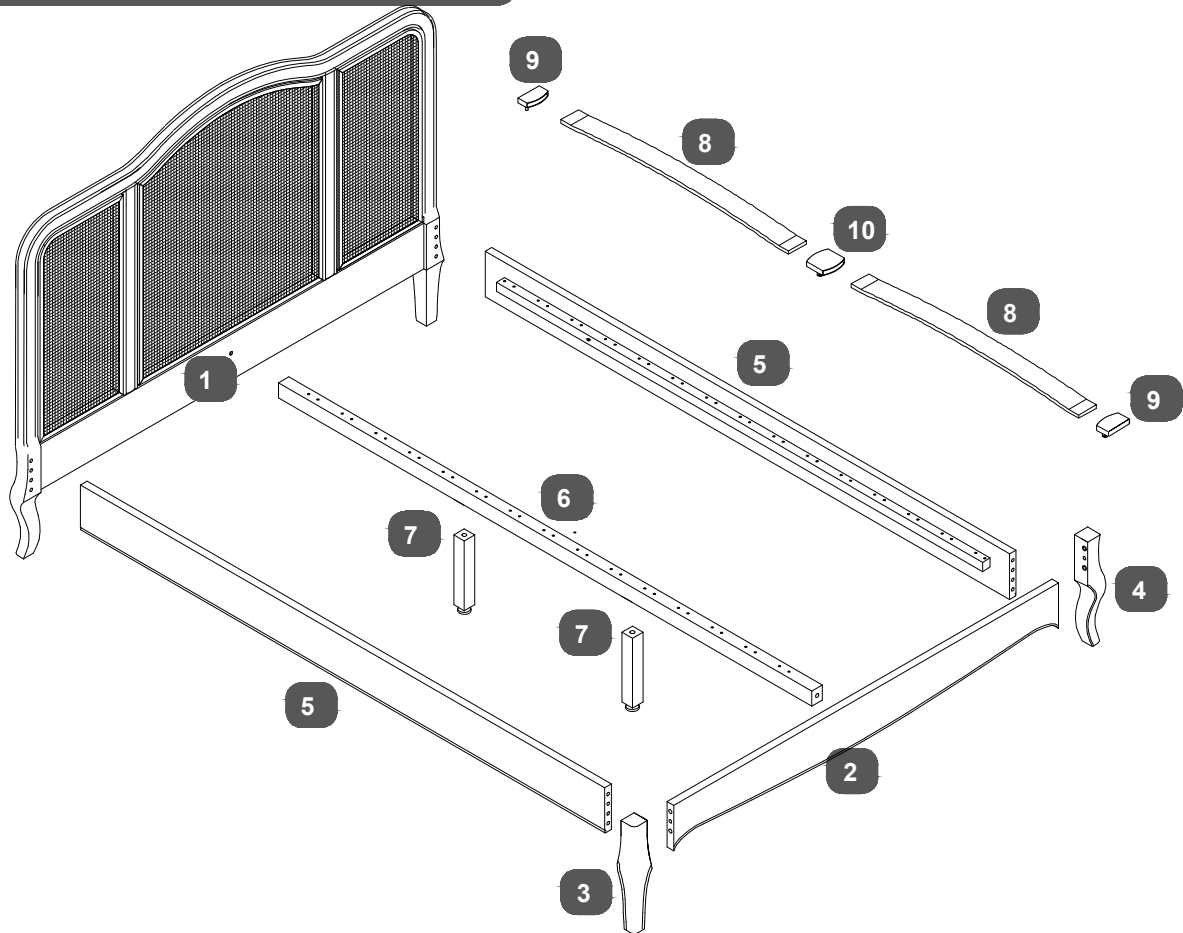







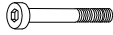

Parts Checklist

Ref.	Description	Qty	Box	Ref.	Description	Qty	Box
1	Headboard	1	1	7	Centre Rail Support Legs	Double / King / Super king	2 / 2 / 4
2	Footboard	1	2	8	Bentwood Slats	Double / King / Super king	28 / 30 / 45
3	LH Legs for FB	1	1	9	Single Plastic Caps	Double / King / Super king	28 / 30 / 30
4	RH Legs for FB	1	1	10	Double Plastic Caps	Double / King / Super king	14 / 15 / 30
5	Side Rails	2	3				
6	Centre Rail	Double & King Super King	1 2				

Fittings Checklist

HARDWARE NEEDED FOR BED ASSEMBLY

Code	Description		Qty	Box	Code	Description		Qty	Box
A	Bolts (M8x35mm) for fitting centre rail support legs		x2	3	E	Spring washers for M8 bolts		x14	3
		Double&King					Super King		
B	Bolts (M8x80mm) for fitting side rails (3&4) to headboard (1) and footboard (2)		x14	3	F	Bracket		x14	3
		Double&King					Super King		
C	Nuts for M8 bolts		x14	3	G	Spanner for M8 bolts		x1	3
		Double&King					Super King		
D	Flat washers for M8 bolts		x14	3	H	Dowel (M10 x40mm)		x10	3
		Double&King					Super King		
					K	Allen key for M8 bolts		x1	3

Care & Maintenance

In the unlikely event of missing or damaged parts, please contact your retailer. Please have this guide at hand quoting the part code reference numbers shown when requesting spare or replacement parts.



General Hints & Tips

Please retain your assembly instruction and tools provided for future use. Periodically check that all bolts are still tight.







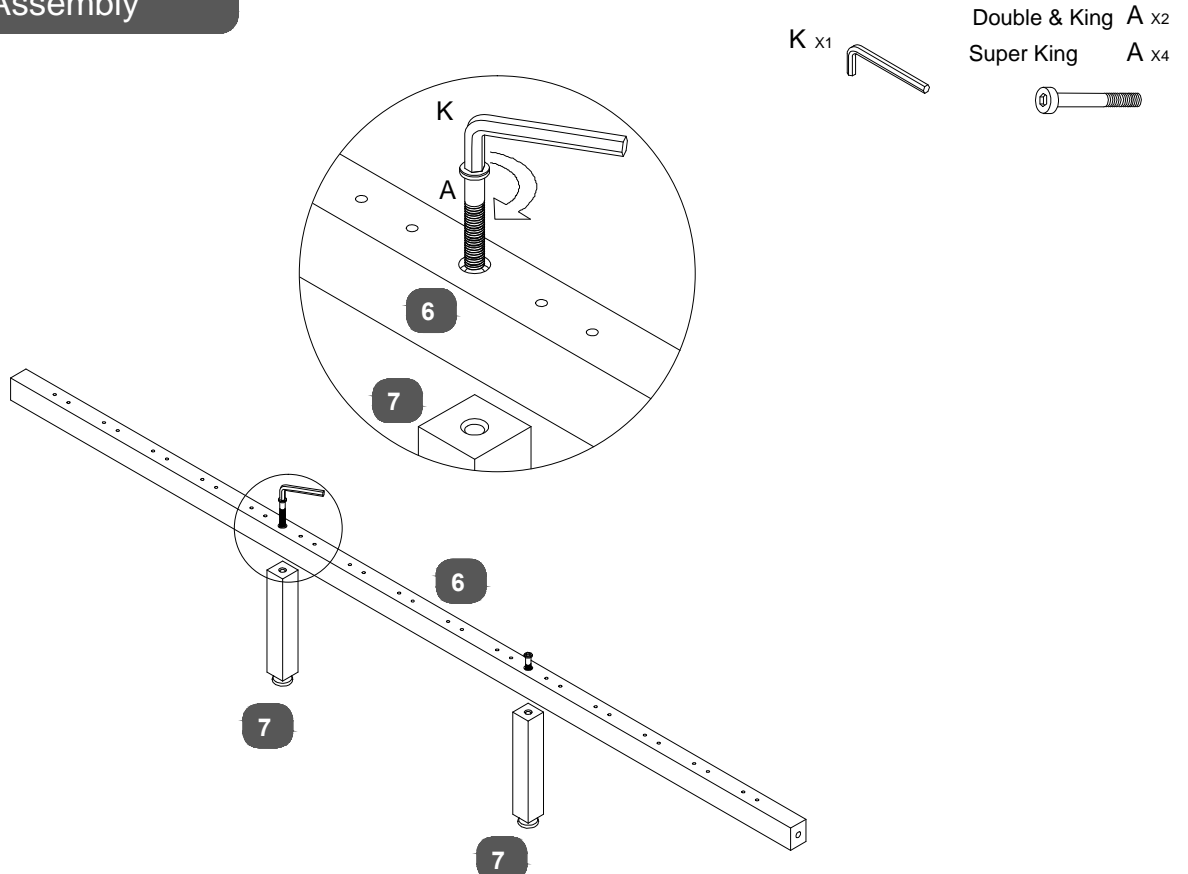

Approximate time to assemble this product

Bed Assembly

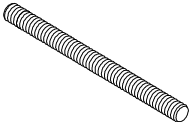
Stage
1

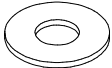

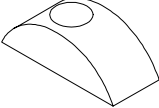



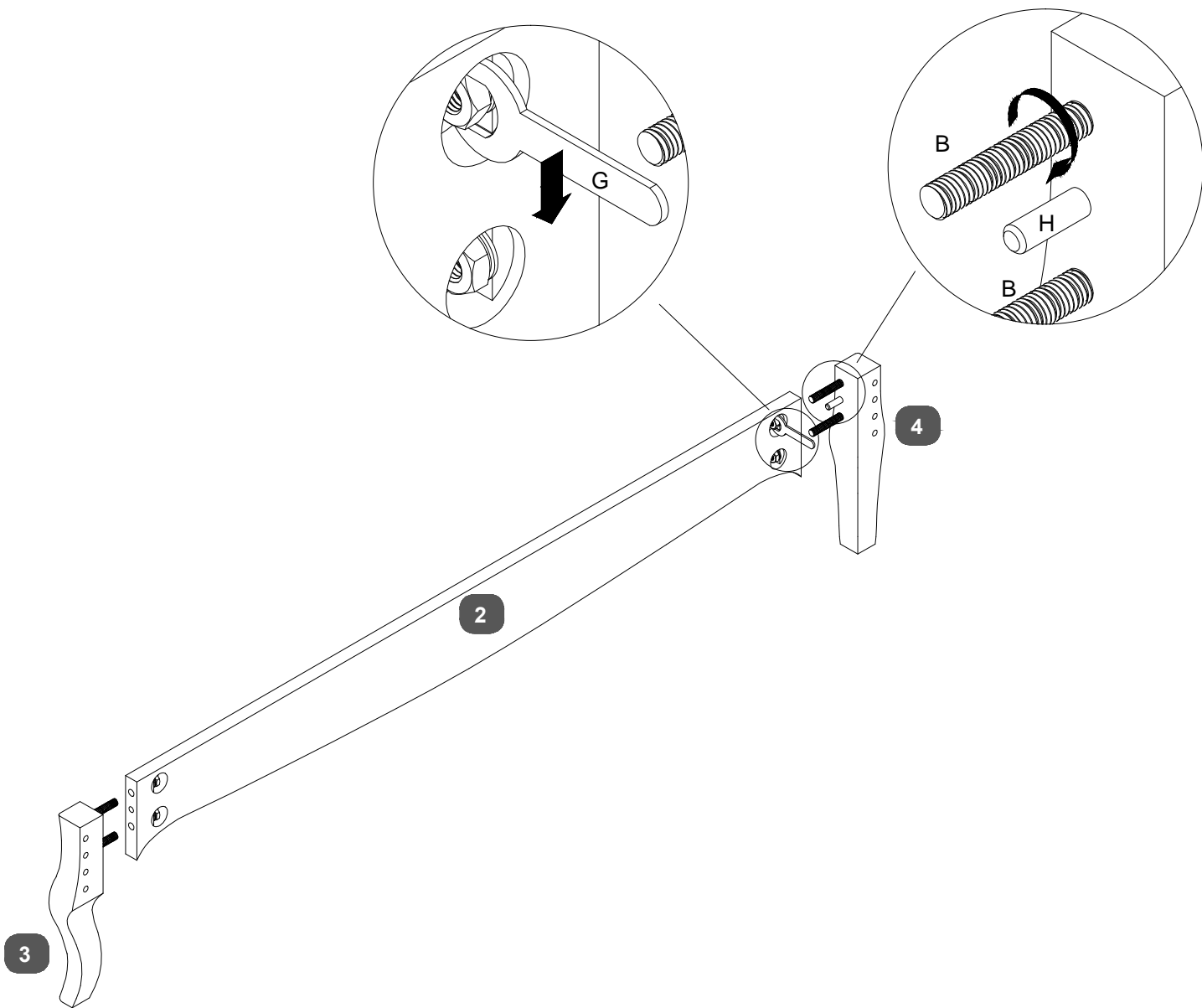

Stage
2

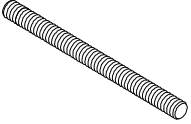
- B  x4
- C  x4
- D  x4
- H  x2
- E  x4
- F  x4
- G  x1

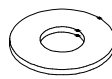

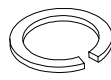
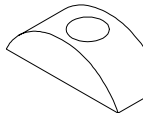



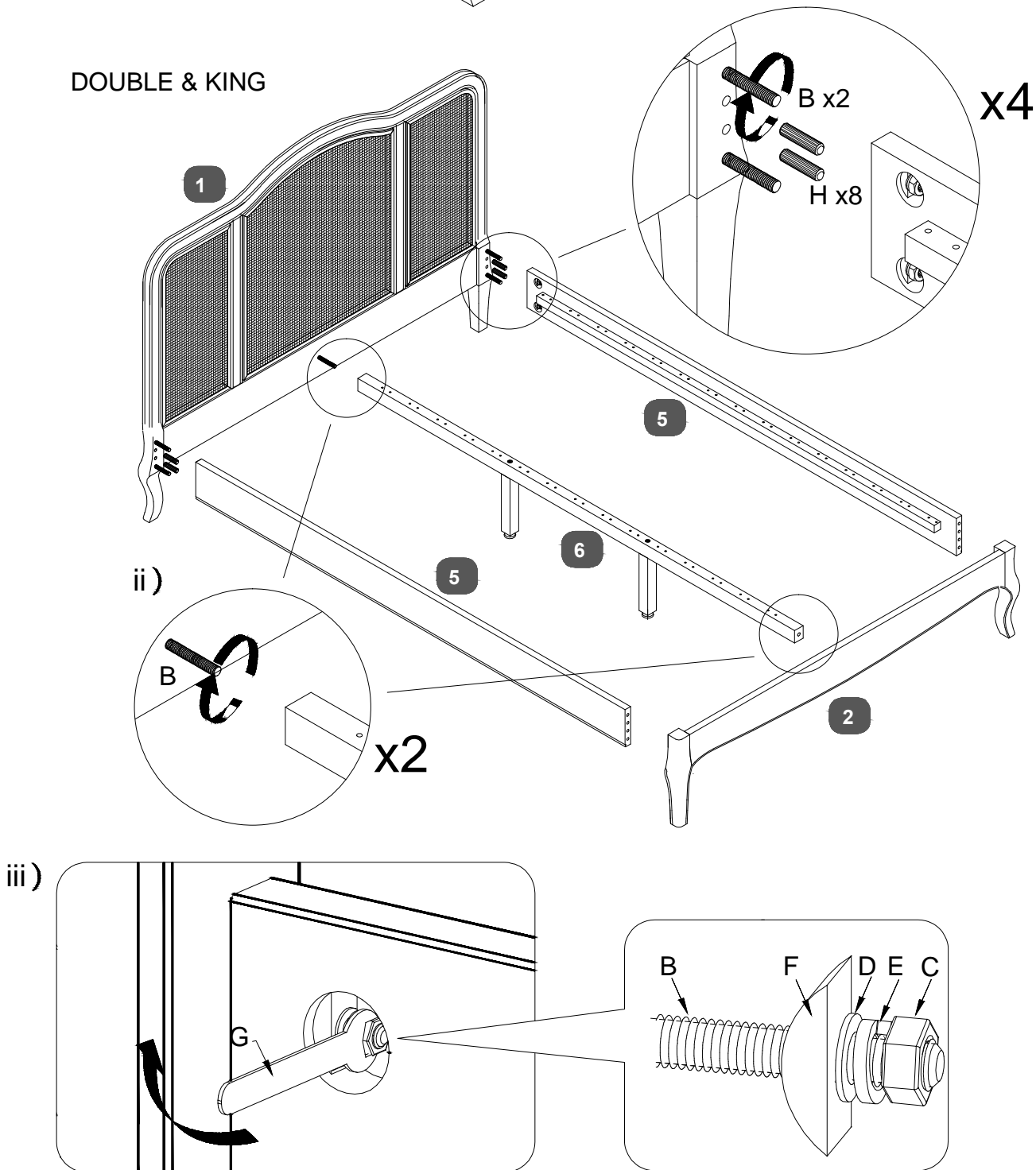

Stage
3

- B  x10
- C  x10
- D  x10
- H  x8
- E  x10
- F  x10
- G  x1

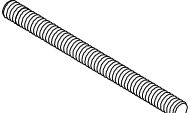
DOUBLE & KING

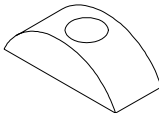

Stage
3a

- B  x12
- C  x12
- D  x12
- H  x8
- E  x12
- F  x12
- G  x1

SUPER KING

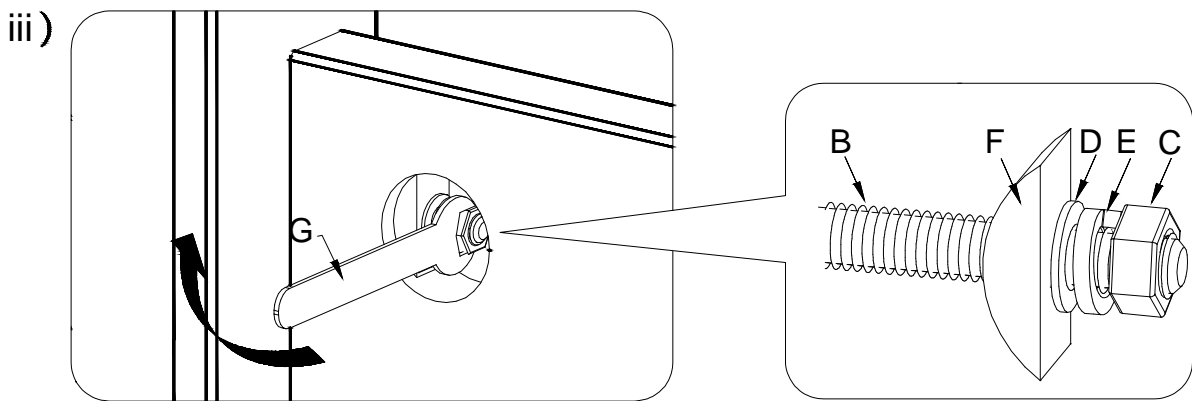
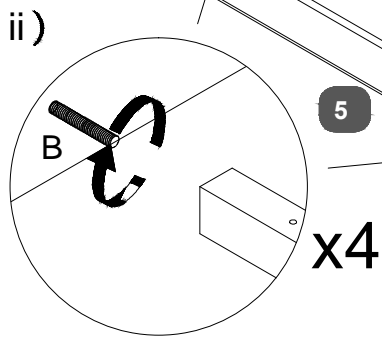
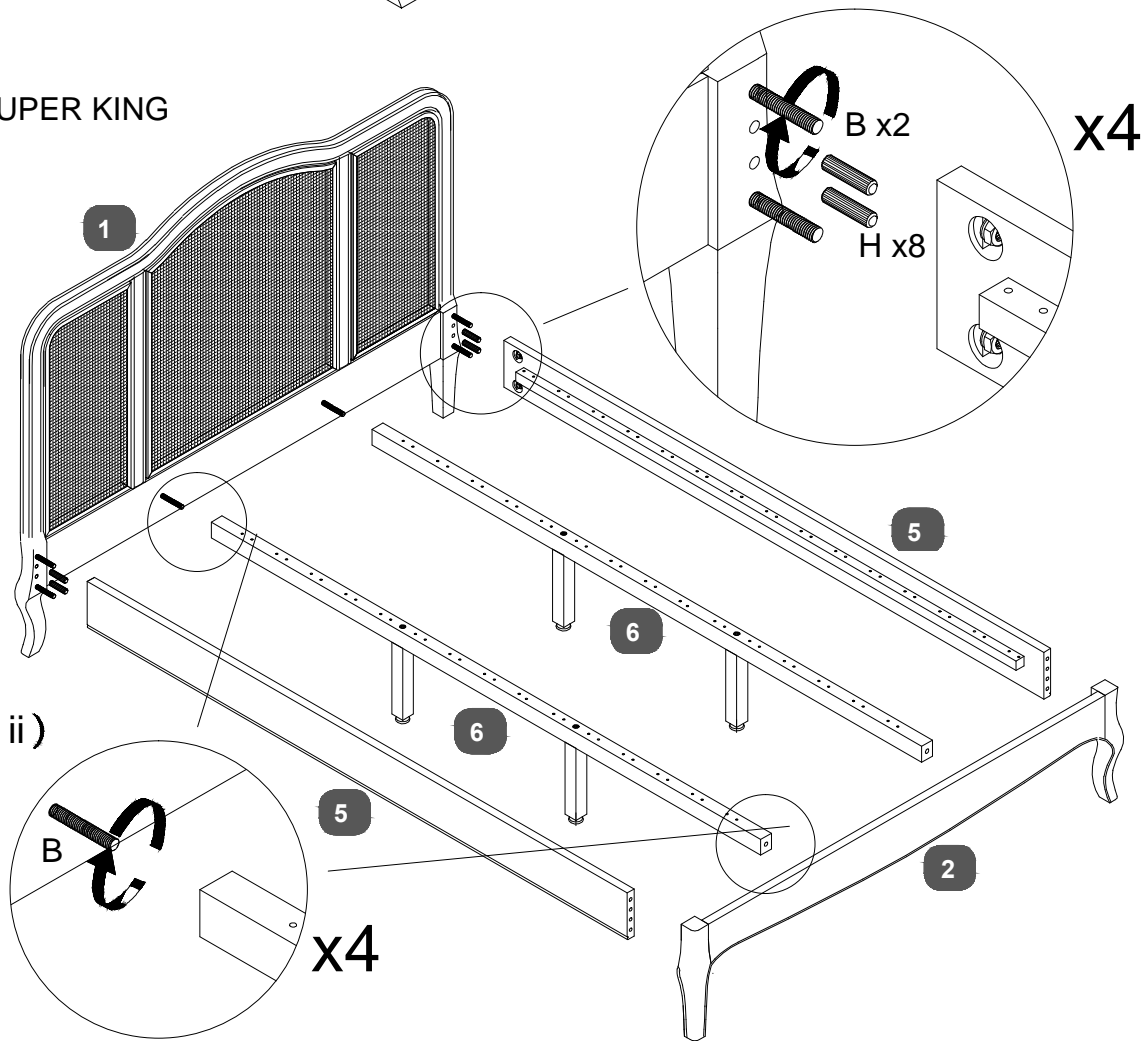

Stage
4

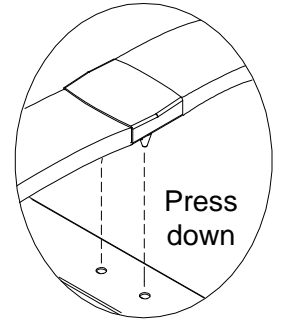
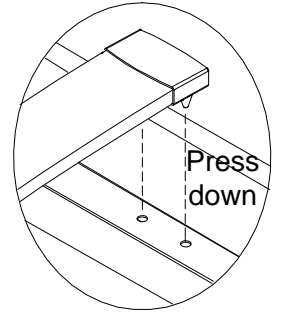
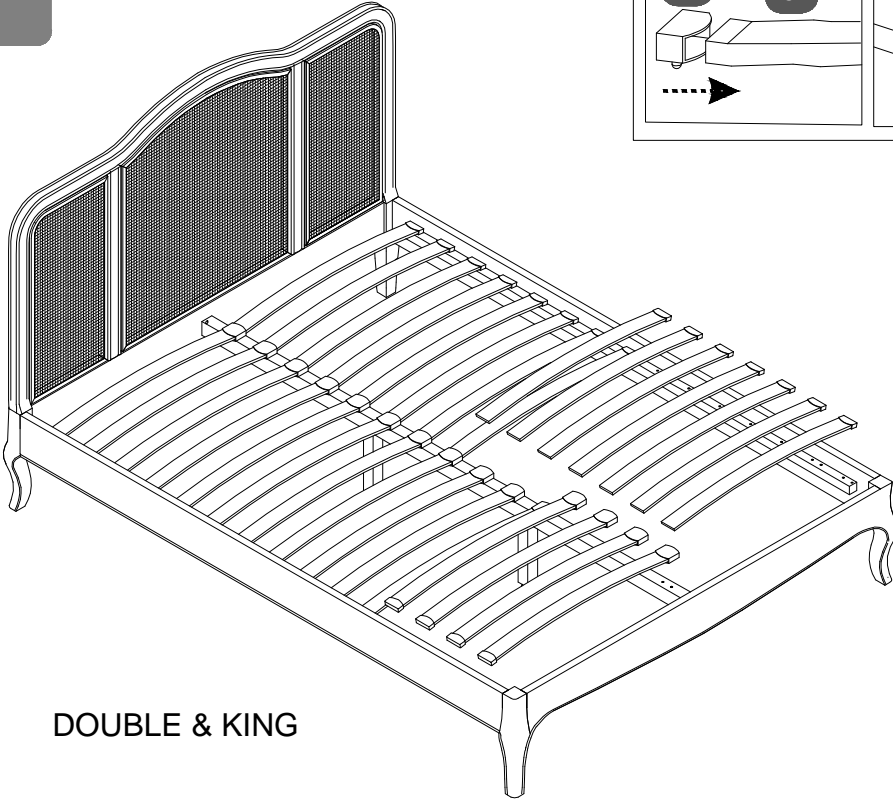
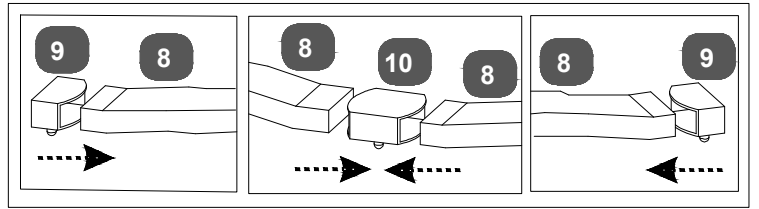

Stage
4a

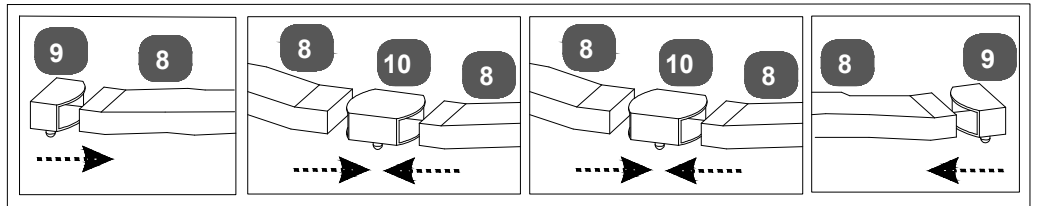

SUPER KING

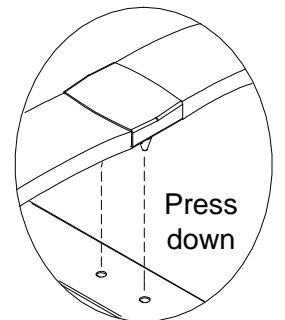
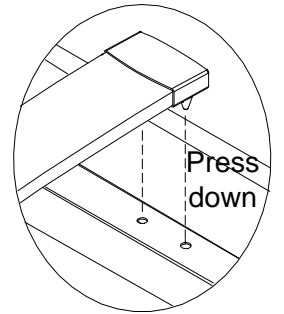
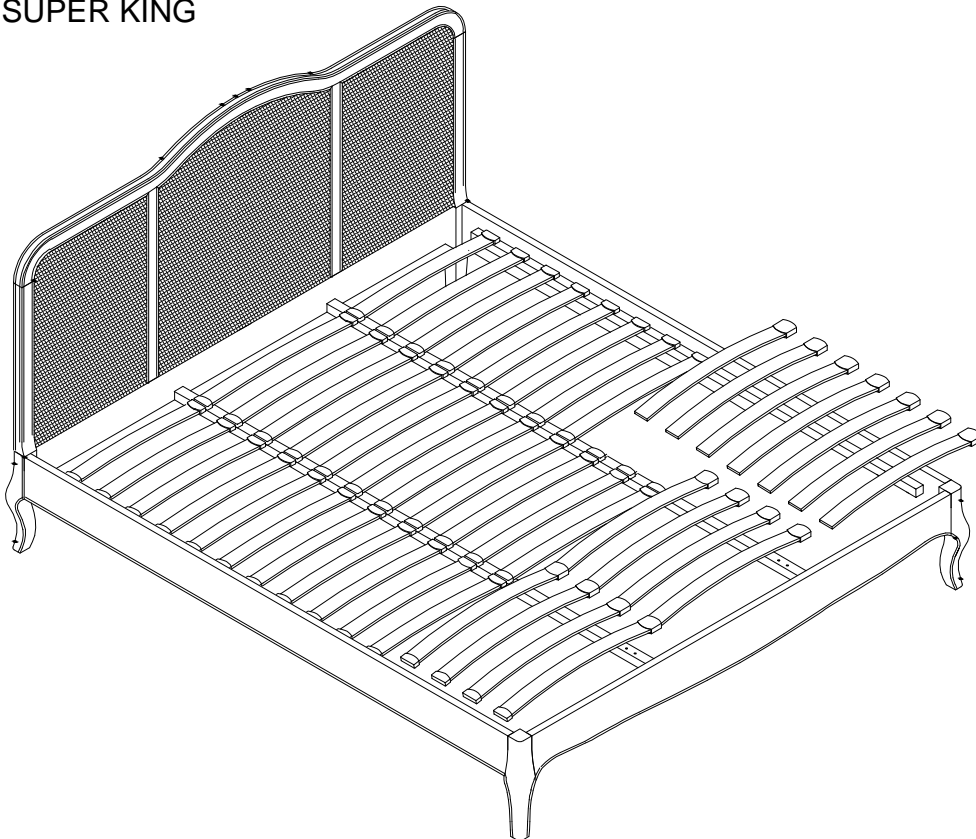

Overall Dimensions (LWH cm)

Double: 203 x 145 x 116

King: 213 x 160 x 116

Super King: 213 x 190 x 116

Storage Dimensions (LWH cm)

Double: 193 x 137.5

King: 203 x 152.5

Super King: 203 x 183.5

Slats Dimensions (LWH cm)

Double: 67.5 x 5.3 x 0.9

King: 75.1 x 5.3 x 0.9

Super King: 60.0 x 5.3 x 0.9

Distance between slats (cm)

8

